

# BRCS035N08SHBD

Rev.A Feb.-2023

## 描述 / Descriptions

TO-263 塑封封装 N 沟道场效应管。  
N-CHANNEL MOSFET in a TO-263 Plastic Package.

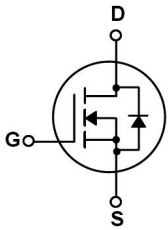
## 特征 / Features

低电阻,开关速度快,无卤产品。  
Ultra Low On-Resistance,fast switching, HF Product.

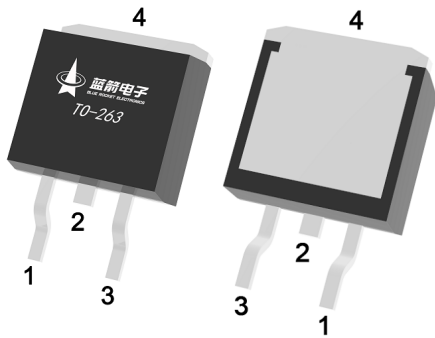
## 用途 / Applications

BMS 设备,大功率逆变器系统,电力设备。  
BMS appliances, High power inverter system, Power appliances

## 内部等效电路 / Equivalent Circuit



## 引脚排列 / Pinning



PIN1 : G      PIN 2、 4 : D      PIN 3 : S

## 印章代码 / Marking

见印章说明。  
See Marking Instructions.

**极限参数 / Absolute Maximum Ratings(Ta=25°C)**

参数 Parameter	符号 Symbol	数值 Rating	单位 Unit
Drain-Source Voltage	V <sub>DS</sub>	80	V
Drain Current	I <sub>D</sub> (Tc=25°C)	195	A
Pulsed Drain Current	I <sub>DM</sub>	400	A
Gate-Source Voltage	V <sub>GS</sub>	±20	V
Single Pulsed Avalanche Energy L=0.5mH	E <sub>AS</sub>	1200	mJ
Avalanche Current	I <sub>AS</sub>	47.5	A
Total Power Dissipation	P <sub>D</sub> (Tc=25°C)	227	W
Junction and Storage Temperature Range	T <sub>J</sub> , T <sub>STG</sub>	-55 to 150	°C
Thermal Resistance-Junction to Ambient	t ≤ 10s	R <sub>θJA</sub>	°C/W
	Steady-State		
Thermal Resistance-Junction to Case	Steady-State	R <sub>θJC</sub>	60
			0.55

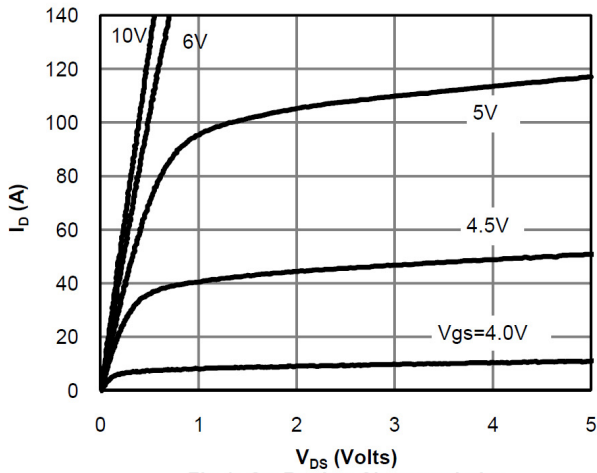
**电性能参数 / Electrical Characteristics(Ta=25°C)**

参数 Parameter	符号 Symbol	测试条件 Test Conditions	最小值 Min	典型值 Typ	最大值 Max	单位 Unit
Drain-Source Breakdown Voltage	BV <sub>DSS</sub>	V <sub>GS</sub> =0V I <sub>D</sub> =250μA	80	94		V
Zero Gate Voltage Drain Current	I <sub>DSS</sub>	V <sub>DS</sub> =80V V <sub>GS</sub> =0V			1	μA
Gate-Body Leakage Current Forward	I <sub>GSS</sub>	V <sub>GS</sub> =±20V V <sub>DS</sub> =0V			±100	nA
Gate Threshold Voltage	V <sub>GS(th)</sub>	V <sub>DS</sub> =V <sub>GS</sub> I <sub>D</sub> =250μA	2	2.9	4	V
Static Drain-Source On-Resistance	R <sub>DS(on)</sub>	V <sub>GS</sub> =10V I <sub>D</sub> =30A		2.9	3.5	mΩ
Forward On Voltage	V <sub>SD</sub>	V <sub>GS</sub> =0V I <sub>S</sub> =1A			1.2	V
Input Capacitance	C <sub>iss</sub>	V <sub>DS</sub> =25V V <sub>GS</sub> =0V f=1MHz		6350		pF
Output Capacitance	C <sub>oss</sub>			2440		
Reverse Transfer Capacitance	C <sub>rss</sub>			305		

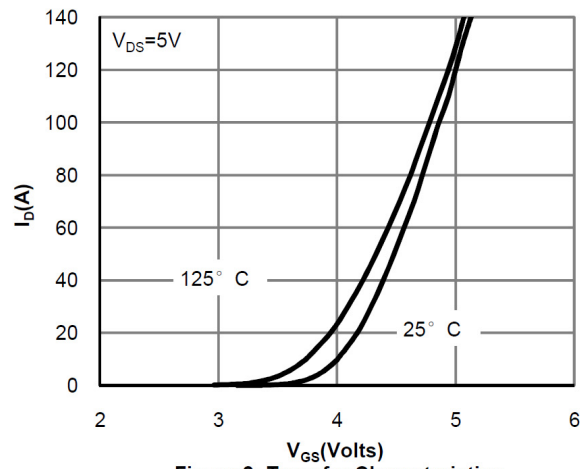
## 电性能参数 / Electrical Characteristics(Ta=25°C)

参数 Parameter	符号 Symbol	测试条件 Test Conditions	最小值 Min	典型值 Typ	最大值 Max	单位 Unit
Gate resistance	R <sub>g</sub>	f=1MHz		1.6		Ω
Total Gate Charge	Q <sub>g</sub>	V <sub>GS</sub> =10V    V <sub>DS</sub> =40V I <sub>D</sub> =20A		128		nC
Gate Source Charge	Q <sub>gs</sub>			36		
Gate Drain Charge	Q <sub>gd</sub>			23		
Turn-On Delay Time	t <sub>d(on)</sub>	V <sub>GS</sub> =10V    V <sub>DS</sub> =40V R <sub>L</sub> =2Ω        R <sub>GEN</sub> =3Ω		25		ns
Turn-On Rise Time	t <sub>r</sub>			19		
Turn-Off Delay Time	t <sub>d(off)</sub>			56		
Turn-Off Fall Time	t <sub>f</sub>			18		

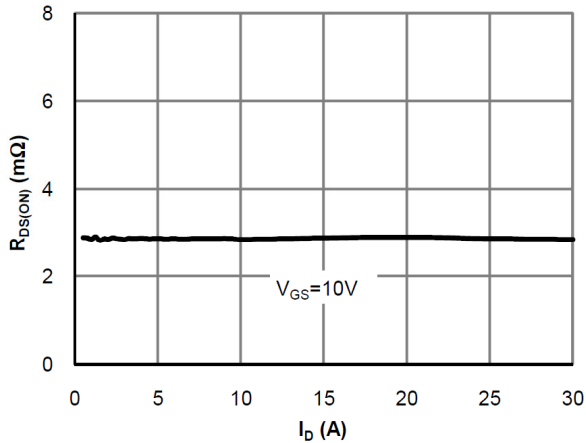
**电参数曲线图 / Electrical Characteristic Curve**



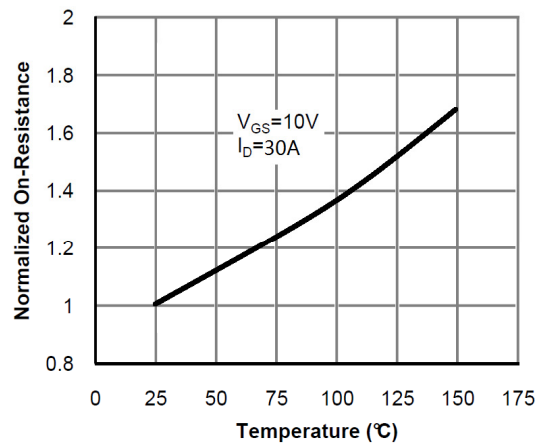
**Fig 1: On-Region Characteristics**



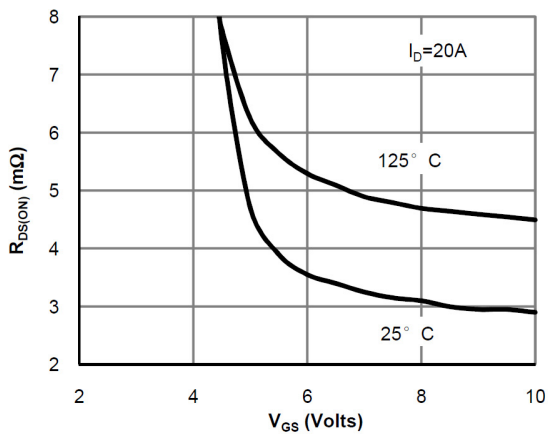
**Figure 2: Transfer Characteristics**



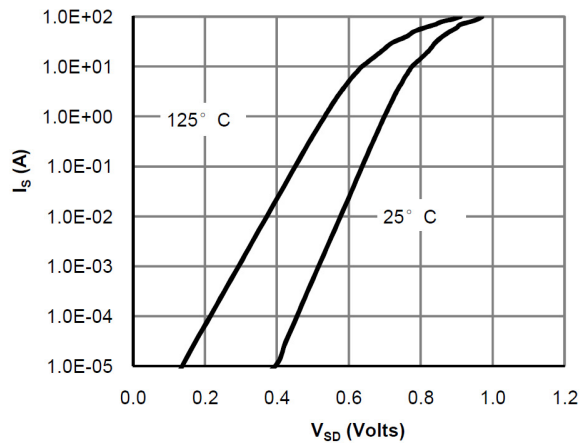
**Figure 3: On-Resistance vs. Drain Current and Gate Voltage**



**Figure 4: On-Resistance vs. Junction Temperature**

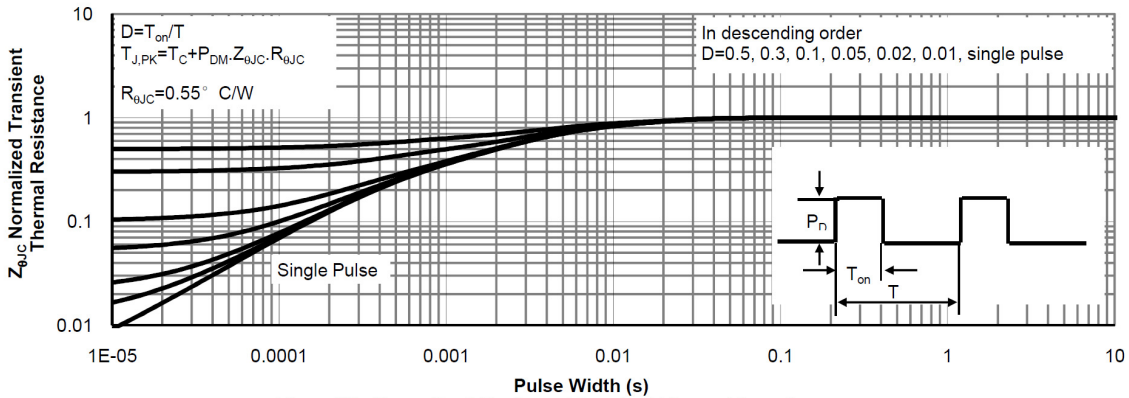
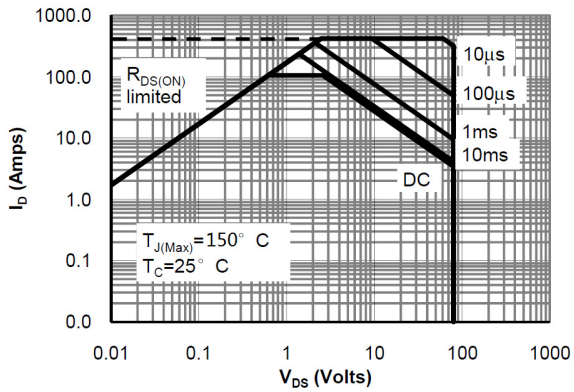
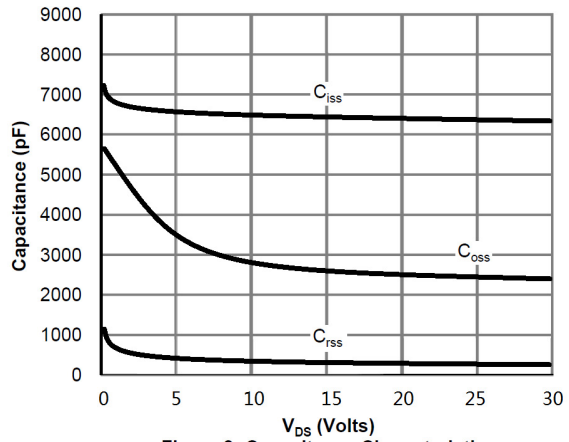
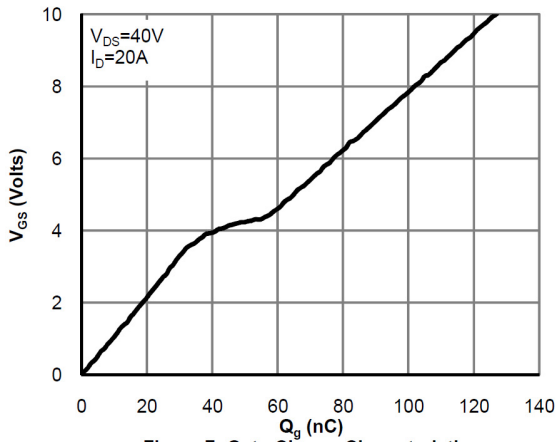


**Figure 5: On-Resistance vs. Gate-Source Voltage**

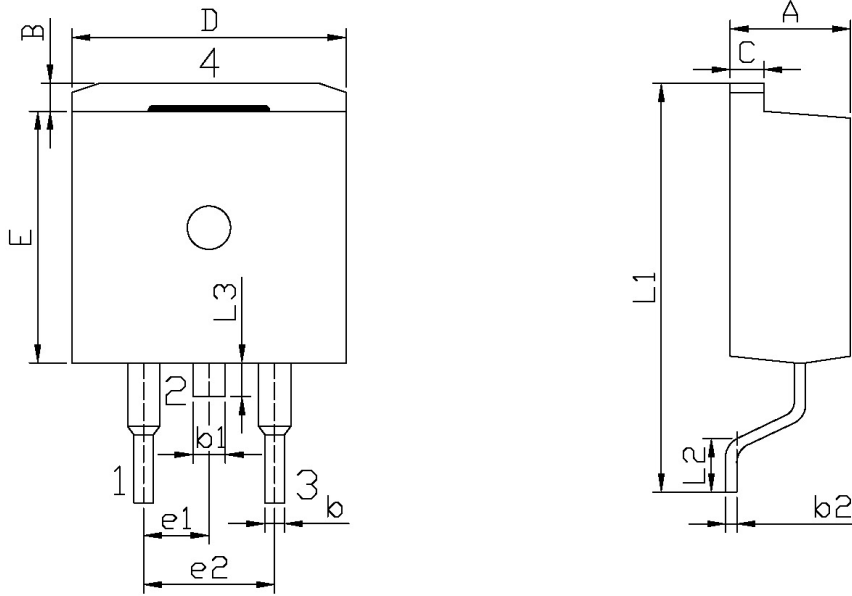


**Figure 6: Body-Diode Characteristics**

## 电参数曲线图 / Electrical Characteristic Curve



**外形尺寸图 / Package Dimensions**

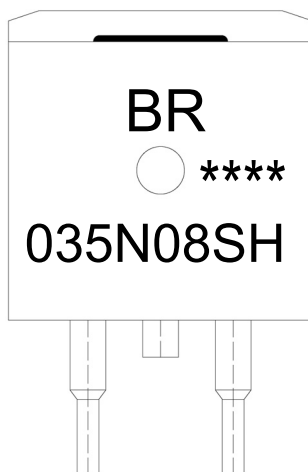


单位: mm

Symbol	Dimensions In Millimeters		Symbol	Dimensions In Millimeters	
	Min	Max		Min	Max
A	4.30	4.70	E	9.00	9.40
B	1.00	1.40	e1	2.34	2.74
b	0.70	0.90	e2	4.88	5.28
b1	1.15	1.35	L1	15.00	16.00
b2	0.40	0.60	L2	2.24	2.84
C	1.20	1.40	L3	1.20	1.60
D	9.80	10.20			

TQ-263

## 印章说明 / Marking Instructions



说明：

BR： 为公司代码

035N08SH： 为型号代码

\*\*\*\*： 为生产批号代码，随生产批号变化

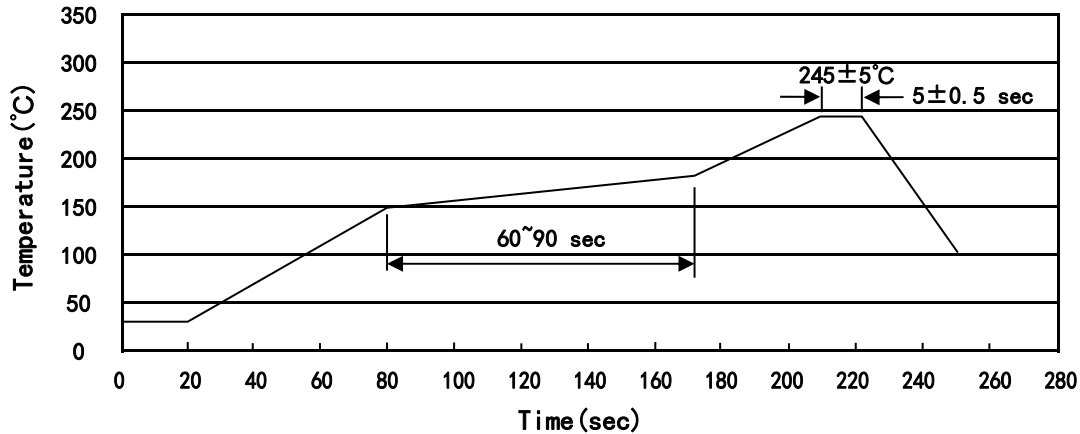
Note:

BR: Company Code

035N08SH: Product Type

\*\*\*\*: Lot No. Code, code change with Lot No

**回流焊温度曲线图(无铅) / Temperature Profile for IR Reflow Soldering(Pb-Free)**



说明：

- 1、预热温度 150~180°C，时间 60~90sec;
- 2、峰值温度 245±5°C，时间持续为 5±0.5sec;
- 3、焊接制程冷却速度为 2~10°C/sec.

Note:

- 1.Preheating:150~180°C, Time:60~90sec.
- 2.Peak Temp.:245±5°C, Duration:5±0.5sec.
3. Cooling Speed: 2~10°C/sec.

**耐焊接热试验条件 / Resistance to Soldering Heat Test Conditions**

温度：260±5°C

时间：10±1 sec.

Temp.:260±5°C

Time:10±1 sec

**包装规格 / Packaging SPEC.**

卷盘包装 / REEL

Package Type 封装形式	Units 包装数量					Dimension 包装尺寸 (unit: mm <sup>3</sup> )		
	Units/Reel 只/卷盘	Reels/Inner Box 卷盘/盒	Units/Inner Box 只/盒	Inner Boxes/Outer Box 盒/箱	Units/Outer Box 只/箱	Reel	Inner Box 盒	Outer Box 箱
TO-263	800	1	800	6	4,800	13" ×24	360×360×50	380×335×366

套管包装 / TUBE

Package Type 封装形式	Units 包装数量					Dimension 包装尺寸 (unit: mm <sup>3</sup> )		
	Units/Tube 只/套管	Tubes/Inner Box 套管/盒	Units/Inner Box 只/盒	Inner Boxes/Outer Box 盒/箱	Units/Outer Box 只/箱	Tube 套管	Inner Box 盒	Outer Box 箱
TO-263	50	20	1,000	5	5,000	532×33×7.0	555×164×50	575×290×180

**使用说明 / Notices**