

# BRCS045N03YM

Rev.A May.-2024

## 描述 / Descriptions

PDFN5×6A 塑封封装双 N 沟道场效应管。

Dual N-CHANNEL MOSFET in a PDFN5×6A Plastic Package .

## 特征 / Features

$V_{DS}(V)=30V$      $I_D=64A$

$R_{DS(ON)}@10V<4.5m\Omega$ (Typ. 4.3 m $\Omega$ )

$R_{DS(ON)}@4.5V<6.5m\Omega$ (Typ. 5.9 m $\Omega$ )

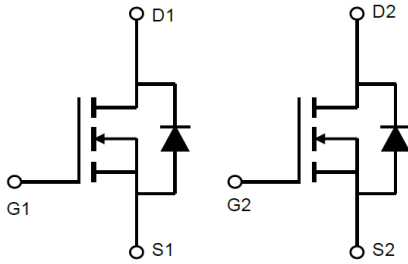
无卤产品。HF Product.

## 用途 / Applications

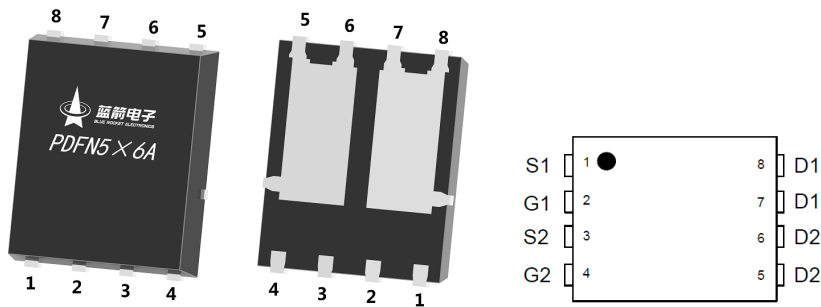
PWM 应用、负载开关、电源管理、LED 调光。

PWM Application, Load Switch, Power Management, Dimming LED.

## 内部等效电路 / Equivalent Circuit



## 引脚排列 / Pinning



## 印章代码 / Marking

见印章说明。

See Marking Instructions.

**极限参数 / Absolute Maximum Ratings(Ta=25°C)**

参数 Parameter	符号 Symbol	数值 Rating	单位 Unit
Drain-Source Voltage	V <sub>DSS</sub>	30	V
Gate-Source Voltage	V <sub>GS</sub>	±20	V
Continuous Drain Current	I <sub>D</sub> (T <sub>C</sub> =25°C)	64	A
Pulsed Drain Current	I <sub>DM</sub>	165	A
Power Dissipation	P <sub>D</sub> (T <sub>C</sub> =25°C)	27.5	W
Junction and Storage Temperature Range	T <sub>J</sub> , T <sub>STG</sub>	-55 to +150	°C
Maximum Junction-to-Ambient	R <sub>θJA</sub> (≤10s)	43	°C/W
Maximum Junction-to-Ambient	R <sub>θJA</sub> (Steady-State)	62	°C/W
Maximum Junction-to-Case	R <sub>θJC</sub> (Steady-State)	4.5	°C/W

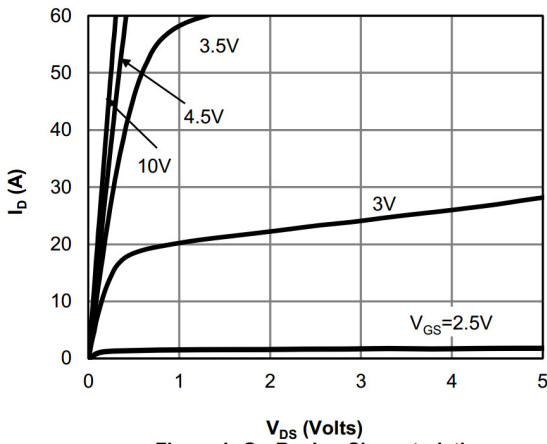
**电性能参数 / Electrical Characteristics(Ta=25°C)**

参数 Parameter	符号 Symbol	测试条件 Test Conditions	最小值 Min	典型值 Typ	最大值 Max	单位 Unit
Drain-Source Breakdown Voltage	BV <sub>DSS</sub>	V <sub>GS</sub> =0V I <sub>D</sub> =250μA	30	36		V
Zero Gate Voltage Drain Current	I <sub>DSS</sub>	V <sub>DS</sub> =30V V <sub>GS</sub> =0V			1	μA
Gate-Body leakage current	I <sub>GSS</sub>	V <sub>GS</sub> =±20V V <sub>DS</sub> =0V			±100	nA
Gate Threshold Voltage	V <sub>GS(th)</sub>	V <sub>DS</sub> =V <sub>GS</sub> I <sub>D</sub> =250μA	1.0	1.7	2.5	V
Static Drain-Source On-Resistance	R <sub>DS(on)</sub>	V <sub>GS</sub> =10V I <sub>D</sub> =20A		4.3	4.5	mΩ
		V <sub>GS</sub> =4.5V I <sub>D</sub> =10A		5.9	6.5	mΩ
Diode Forward Voltage	V <sub>SD</sub>	V <sub>GS</sub> =0V I <sub>S</sub> =1.0A			1.2	V
Input Capacitance	C <sub>iss</sub>	V <sub>DS</sub> =25V V <sub>GS</sub> =0V f=1.0MHz		2100		pF
Output Capacitance	C <sub>oss</sub>			200		pF
Reverse Transfer Capacitance	C <sub>rss</sub>				170	
Gate resistance	R <sub>g</sub>	V <sub>DS</sub> =0V V <sub>GS</sub> =0V f=1.0MHz		2.7		Ω
Total Gate Charge	Q <sub>g(10V)</sub>	V <sub>GS</sub> =10V V <sub>DS</sub> =15V I <sub>D</sub> =20A		63.5		nC
Total Gate Charge	Q <sub>g(4.5V)</sub>			34		nC
Gate-Source Charge	Q <sub>gs</sub>			8.5		nC
Gate-Drain Charge	Q <sub>gd</sub>			16.7		nC

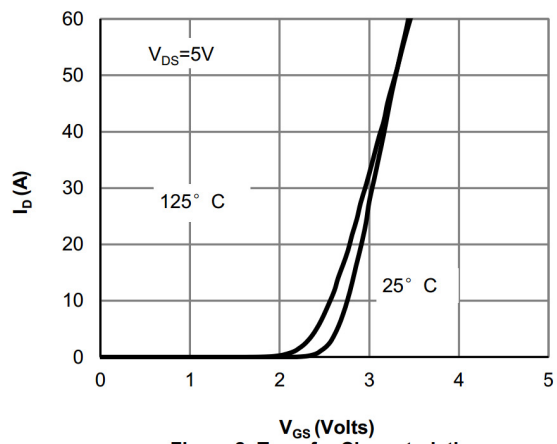
## 电性能参数 / Electrical Characteristics(Ta=25℃)

参数 Parameter	符号 Symbol	测试条件 Test Conditions	最小值 Min	典型值 Typ	最大值 Max	单位 Unit
Turn-On Delay Time	$t_{d(on)}$	$V_{DS}=15\text{ V}$ $V_{GS}=10\text{ V}$ $R_L=0.75\Omega$ $R_{GEN}=3\Omega$		13.1		ns
Turn-On Rise Time	$t_r$			15.4		ns
Turn-Off Delay Time	$t_{d(off)}$				42	ns
Turn-Off Fall Time	$t_f$				15	ns

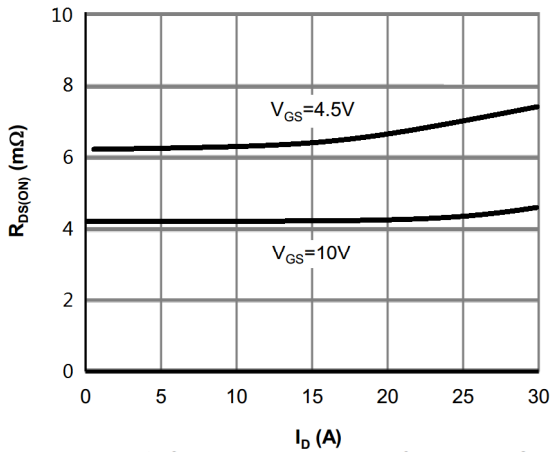
**电参数曲线图 / Electrical Characteristic Curve**



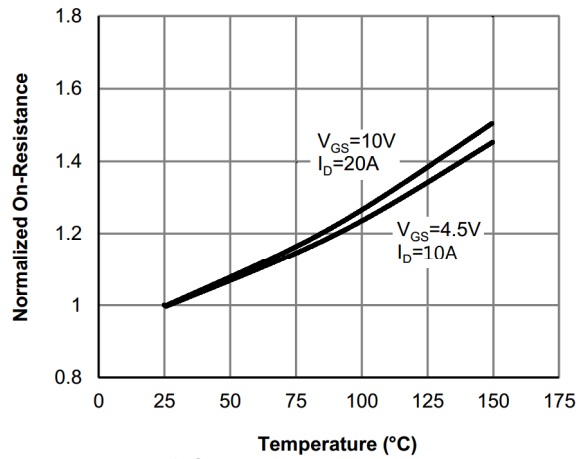
**Figure 1: On-Region Characteristics**



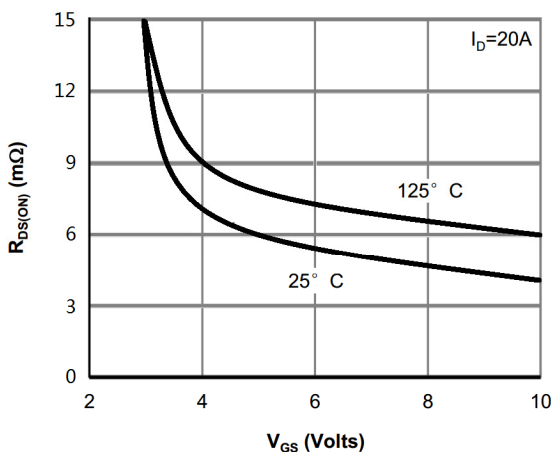
**Figure 2: Transfer Characteristics**



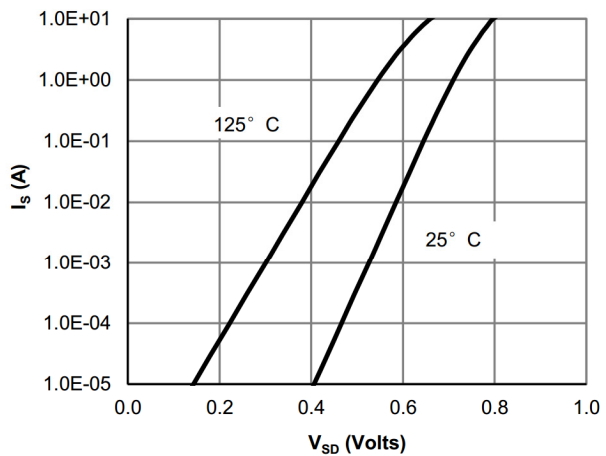
**Figure 3: On-Resistance vs. Drain Current and Gate Voltage**



**Figure 4: On-Resistance vs. Junction Temperature**

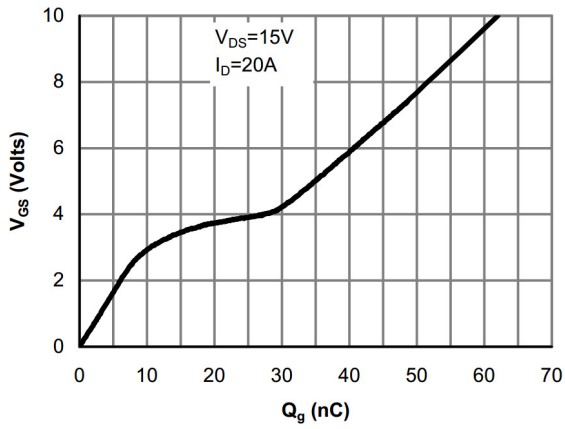


**Figure 5: On-Resistance vs. Gate-Source Voltage**

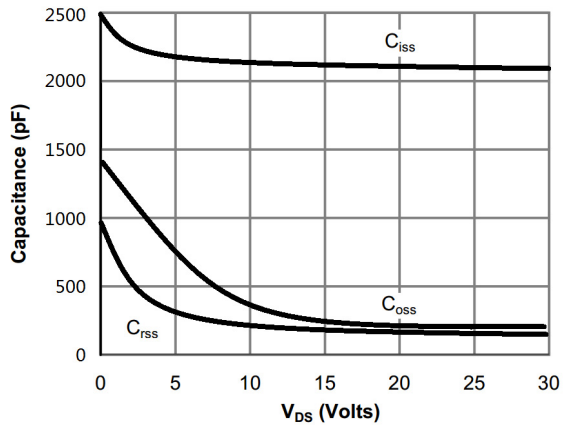


**Figure 6: Body-Diode Characteristics**

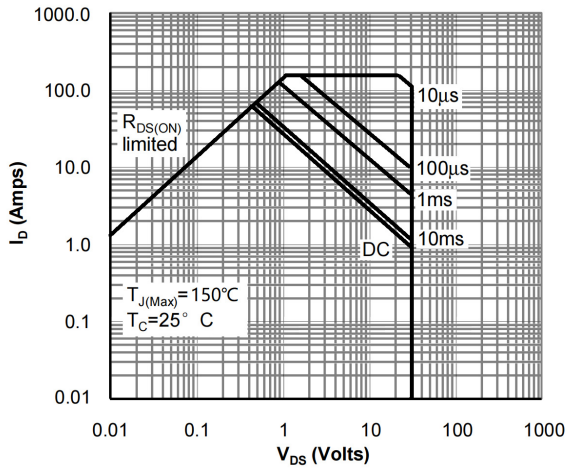
**电参数曲线图 / Electrical Characteristic Curve**



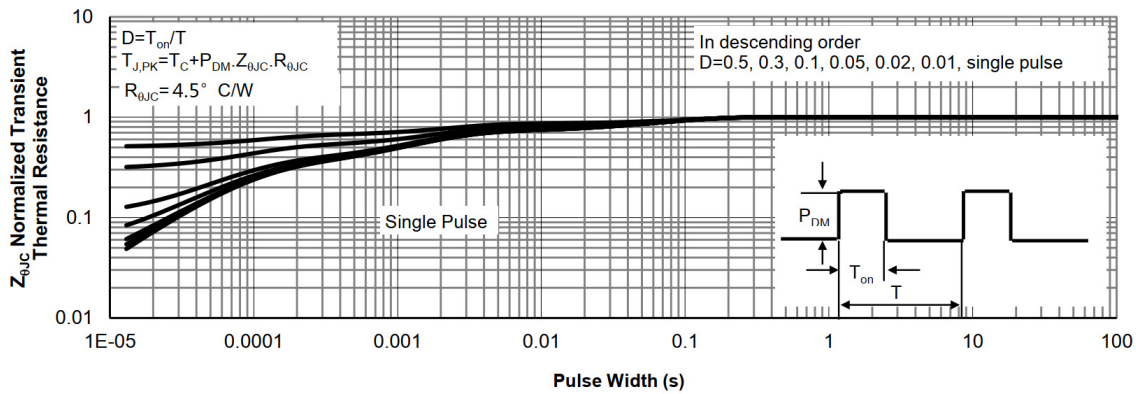
**Figure 7: Gate-Charge Characteristics**



**Figure 8: Capacitance Characteristics**



**Figure 9: Maximum Forward Biased Safe Operating Area**

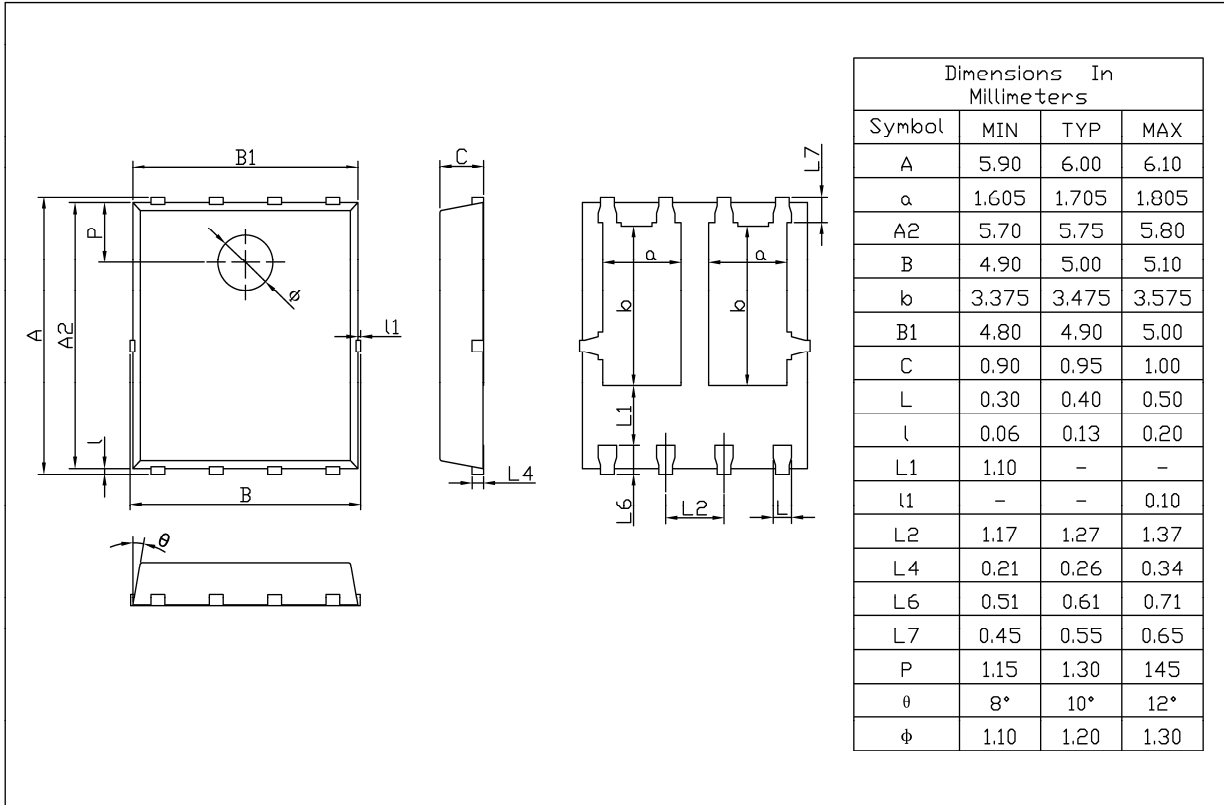


**Figure 10: Normalized Maximum Transient Thermal Impedance**

**外形尺寸图 / Package Dimensions**

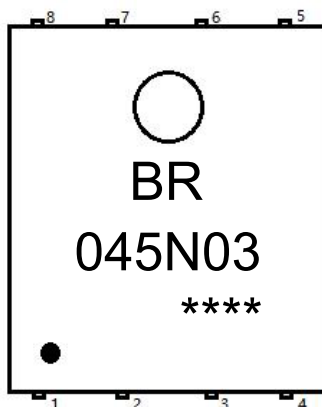
PDFN5 X6A

Unit:mm



Rev.01 202209

## 印章说明 / Marking Instructions



说明：

BR： 为公司代码

045N03： 为型号代码

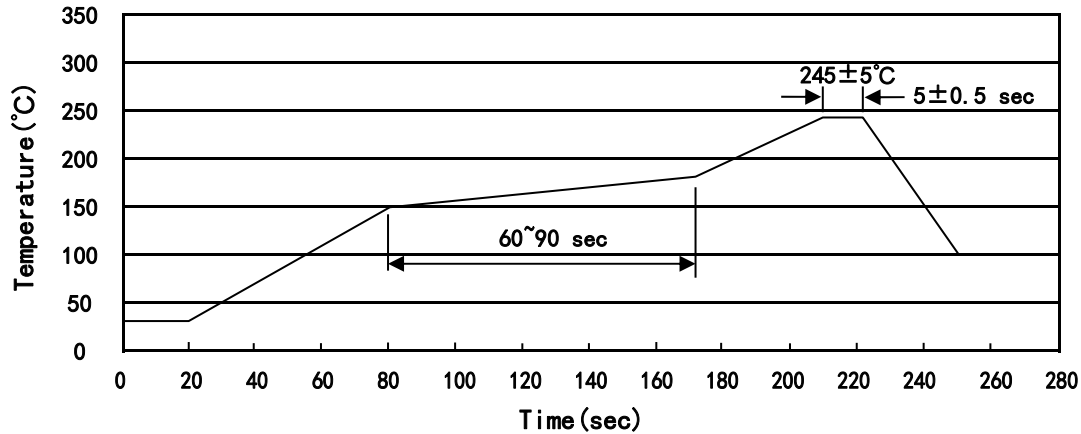
\*\*\*\*： 为生产批号代码，随生产批号变化

Note：

BR： Company Code

045N03： Product Type Code

\*\*\*\*: Lot No. Code, code change with Lot No

**回流焊温度曲线图(无铅) / Temperature Profile for IR Reflow Soldering(Pb-Free)**


说明：

- 1、预热温度 150~180°C，时间 60~90sec;
- 2、峰值温度 245±5°C，时间持续为 5±0.5sec;
- 3、焊接制程冷却速度为 2~10°C/sec.

Note:

- 1.Preheating:150~180°C, Time:60~90sec.
- 2.Peak Temp.:245±5°C, Duration:5±0.5sec.
3. Cooling Speed: 2~10°C/sec.

**耐焊接热试验条件 / Resistance to Soldering Heat Test Conditions**

温度：260±5°C

时间：10±1 sec.

Temp.:260±5°C

Time:10±1 sec

**包装规格 / Packaging SPEC.**

卷盘包装 / REEL

Package Type 封装形式	Units 包装数量					Dimension 包装尺寸 (unit: mm <sup>3</sup> )		
	Units/Reel 只/卷盘	Reels/Inner Box 卷盘/盒	Units/Inner Box 只/盒	Inner Boxes/Outer Box 盒/箱	Units/Outer Box 只/箱	Reel	Inner Box 盒	Outer Box 箱
PDFN5×6A	5,000	2	10,000	6	60,000	13"×12	360×360×50	380×335×366

**使用说明 / Notices**