

BRCS070P03DP

Rev.B Aug.-2023

描述 / Descriptions

TO-252 塑封封装 P 沟道 MOS 场效应管。
P-CHANNEL MOSFET in a TO-252 Plastic Package.

特征 / Features

阻抗低，开关速度快，无卤产品。
Low On-Resistance, fast switching, HF Product.

用途 / Applications

工业级DC/DC转换器的电源管理。
Power Management of Industrial DC/DC Converter.

内部等效电路 / Equivalent Circuit

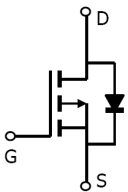

引脚排列 / Pinning

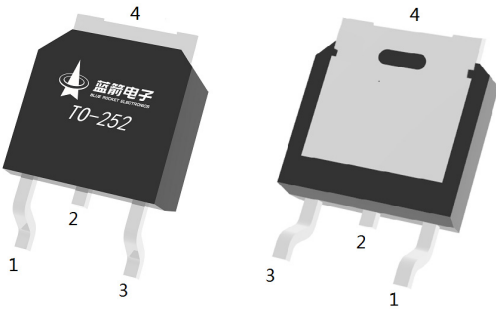

PIN 1 : G

PIN 2 : D

PIN 3 : S

PIN 4 : D

印章代码 / Marking

见印章说明。 See Marking Instructions.

极限参数 / Absolute Maximum Ratings($T_a=25^{\circ}\text{C}$)

参数 Parameter	符号 Symbol	数值 Rating	单位 Unit
Drain-Source Voltage	V_{DS}	-30	V
Drain Current - Continuous	$I_D(T_c=25^{\circ}\text{C})$	-72	A
Drain Current – Pulsed	I_{DM}	-146	A
Gate-Source Voltage	V_{GS}	± 20	V
Power Dissipation	$P_D(T_c=25^{\circ}\text{C})$	65	W
Single Pulse Avalanche Energy(L=0.5mH)	E_{AS}	360	mJ
Avalanche Current(L=0.5mH)	I_{AS}	30	A
Junction and Storage Temperature Range	T_j, T_{stg}	-55 to 150	$^{\circ}\text{C}$
Thermal resistance, junction - ambient	$t \leq 10\text{s}$	$R_{\theta JA}$	$^{\circ}\text{C}/\text{W}$
	Steady-State		
Thermal resistance, junction - case	Steady-State	$R_{\theta JC}$	1.9

电性能参数 / Electrical Characteristics($T_a=25^{\circ}\text{C}$)

参数 Parameter	符号 Symbol	测试条件 Test Conditions	最小值 Min	典型值 Typ	最大值 Max	单位 Unit
Drain-Source Breakdown Voltage	BV_{DSS}	$I_D=-250\mu\text{A}$ $V_{GS}=0\text{V}$	-30	-33		V
Zero Gate Voltage Drain Current	I_{DSS}	$V_{DS}=-30\text{V}$ $V_{GS}=0\text{V}$			-1	μA
Gate-Body leakage current	I_{GSS}	$V_{DS}=0\text{V}$, $V_{GS}=\pm 20\text{V}$			± 100	nA
Gate Threshold Voltage	$V_{GS(th)}$	$V_{DS}=V_{GS}$ $I_D=-250\mu\text{A}$	-1	-1.5	-2.5	V
Static Drain-Source On-Resistance	$R_{DS(ON)}$	$V_{GS}=-10\text{V}$, $I_D=-20\text{A}$		6.5	7	m Ω
		$V_{GS}=-4.5\text{V}$, $I_D=-10\text{A}$		9.5	15	
Diode Forward Voltage	V_{SD}	$I_S=-1\text{A}$, $V_{GS}=0\text{V}$			-1.2	V
Input Capacitance	C_{iss}	$V_{DS}=-25\text{V}$ $V_{GS}=0\text{V}$ $f=1.0\text{MHz}$		3260		pF
Output Capacitance	C_{oss}			335		
Reverse Transfer Capacitance	C_{rss}			330		
Gate resistance	R_g	$V_{GS}=0\text{V}$ $V_{DS}=0\text{V}$ $f=1\text{MHz}$		5.6		Ω
Total Gate Charge	$Q_{g(10V)}$	$V_{GS}=-10\text{V}$, $V_{DS}=-15\text{V}$, $I_D=-20\text{A}$		51		nC
Total Gate Charge	$Q_{g(4.5V)}$			32		
Gate Source Charge	Q_{gs}			11		
Gate Drain Charge	Q_{gd}			13		

电性能参数 / Electrical Characteristics(Ta=25°C)

参数 Parameter	符号 Symbol	测试条件 Test Conditions	最小值 Min	典型值 Typ	最大值 Max	单位 Unit
Turn-On Delay Time	$t_{d(on)}$	$V_{GS}=-10V$ $V_{DS}=-15V$ $R_L=0.75\ \Omega$ $R_{GEN}=3\ \Omega$		12.5		ns
Turn-On Rise Time	t_r			19		
Turn-Off Delay Time	$t_{d(off)}$			125		
Turn-Off Fall Time	t_f			67		

电参数曲线图 / Electrical Characteristic Curve

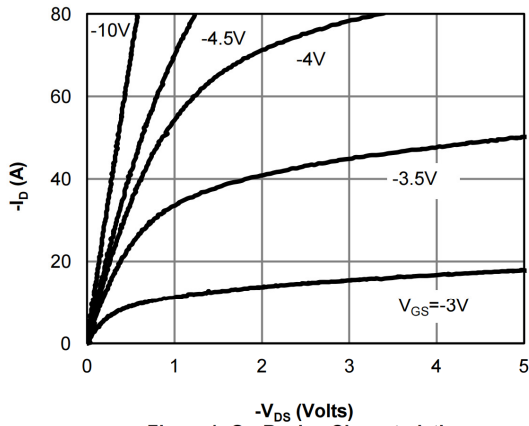

Figure 1: On-Region Characteristics

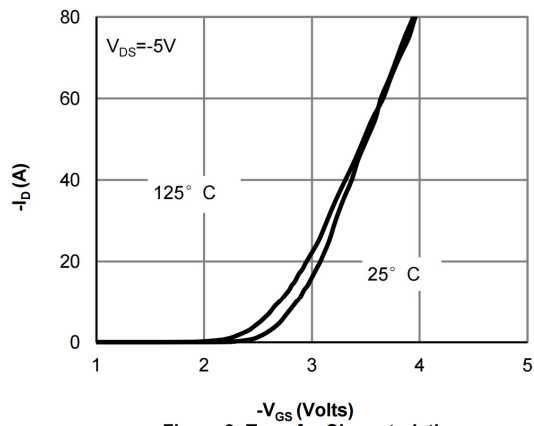

Figure 2: Transfer Characteristics

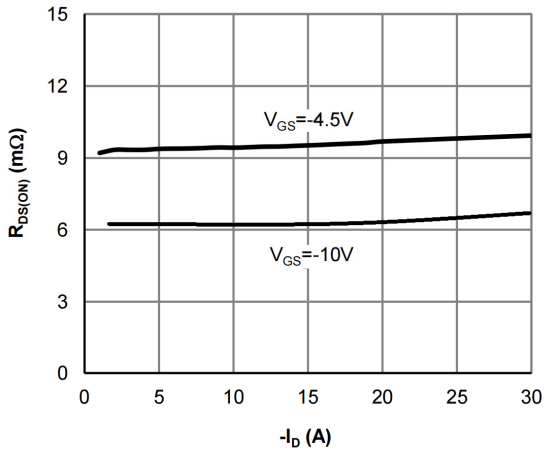

Figure 3: On-Resistance vs. Drain Current and Gate Voltage

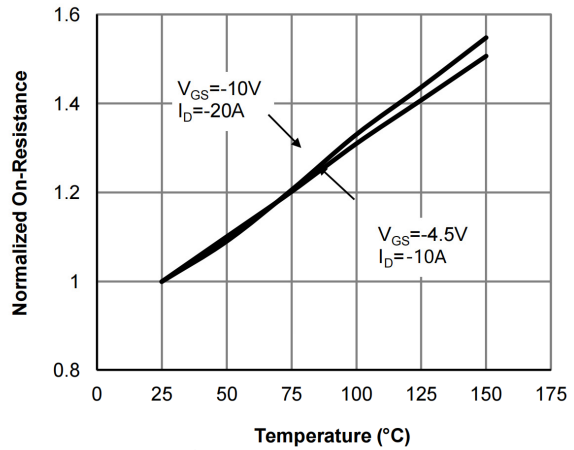

Figure 4: On-Resistance vs. Junction Temperature

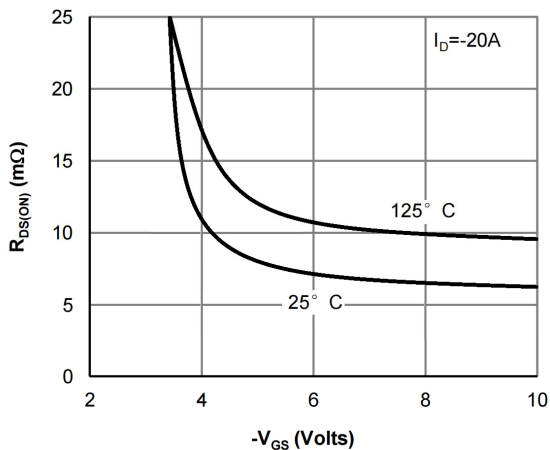

Figure 5: On-Resistance vs. Gate-Source Voltage

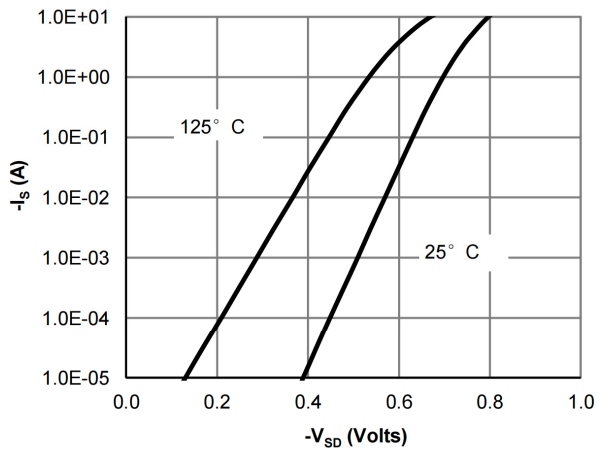

Figure 6: Body-Diode Characteristics

电参数曲线图 / Electrical Characteristic Curve

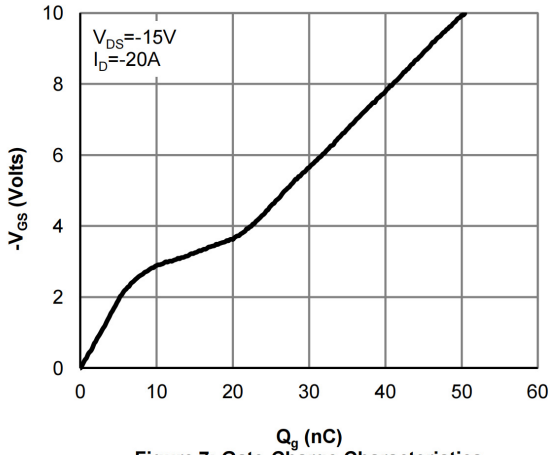

Figure 7: Gate-Charge Characteristics

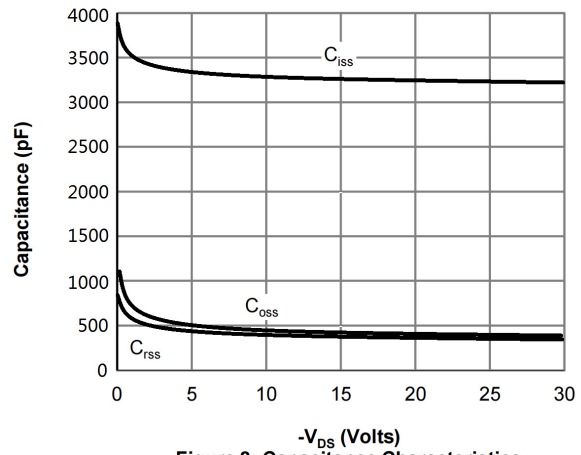

Figure 8: Capacitance Characteristics

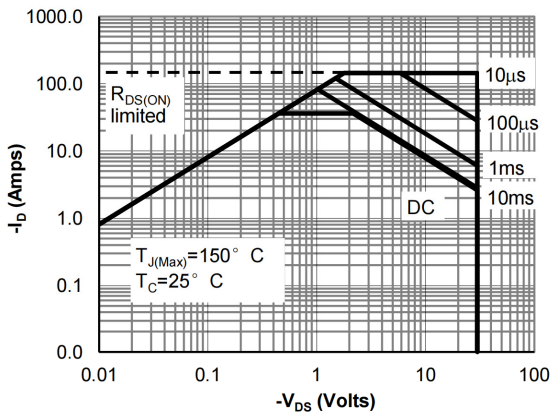

Figure 9: Maximum Forward Biased Safe Operating Area

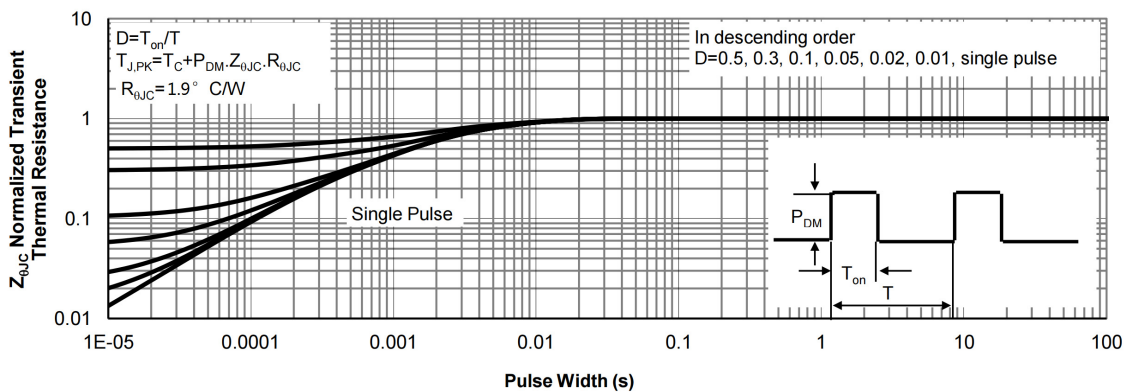
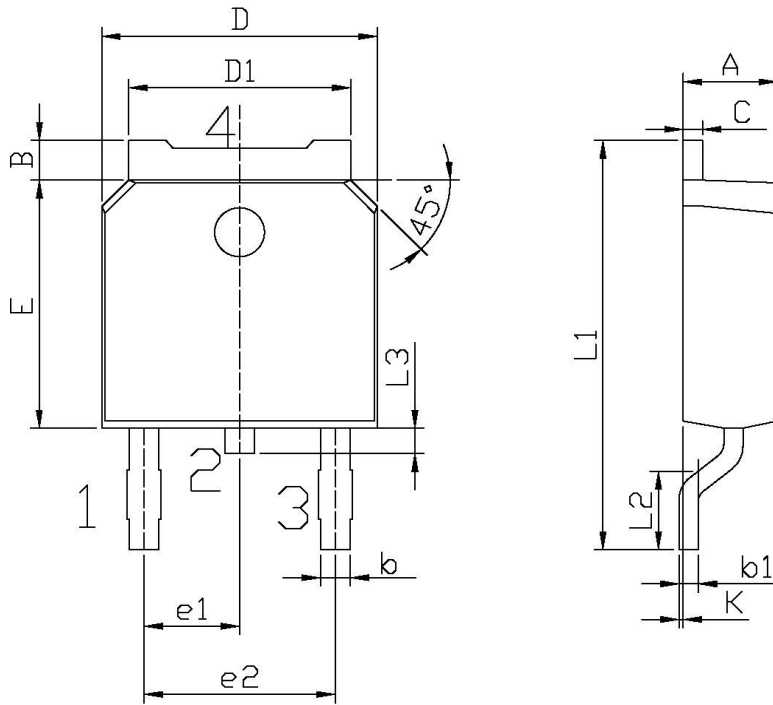

Figure 10: Normalized Maximum Transient Thermal Impedance

外形尺寸图 / Package Dimensions



单位: mm

Symbol	Dimensions In Millimeters		Symbol	Dimensions In Millimeters	
	Min	Max		Min	Max
A	2.20	2.40	E	5.95	6.25
B	0.95	1.25	e1	2.24	2.34
b	0.70	0.90	e2	4.43	4.73
b1	0.45	0.55	L1	9.85	10.35
C	0.45	0.55	L2	1.70	2.00
D	6.45	6.75	L3	0.60	0.90
D1	5.10	5.50	K	0.00	0.10

TO-252

印章说明 / Marking Instructions

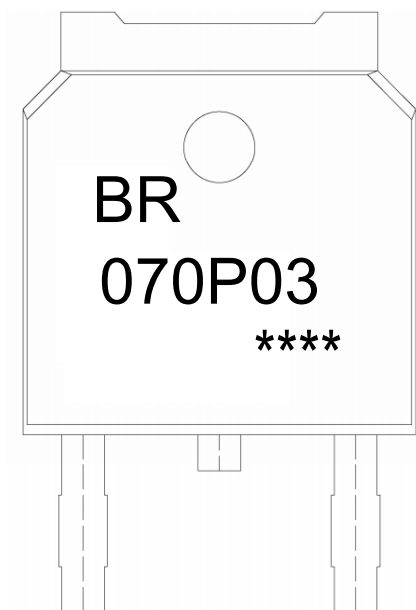

说明：

BR： 为公司代码

070P03： 为产品型号

****： 为生产批号代码，随生产批号变化

Note:

BR: Company Code

070P03: Product Type

****: Lot No. Code, code change with Lot No

回流焊温度曲线图(无铅) / Temperature Profile for IR Reflow Soldering(Pb-Free)

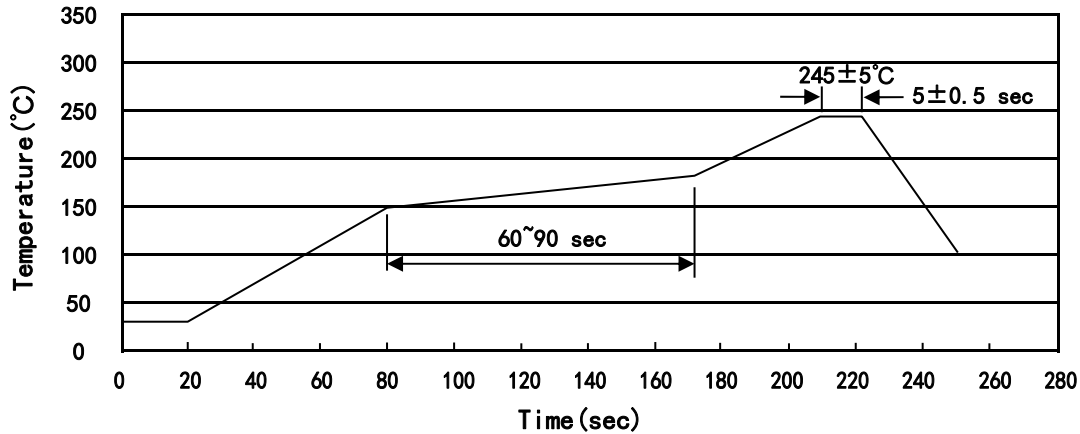

说明：

- 1、预热温度 150~180°C，时间 60~90sec;
- 2、峰值温度 245±5°C，时间持续为 5±0.5sec;
- 3、焊接制程冷却速度为 2~10°C/sec.

Note:

- 1.Preheating:150~180°C, Time:60~90sec.
- 2.Peak Temp.:245±5°C, Duration:5±0.5sec.
3. Cooling Speed: 2~10°C/sec.

耐焊接热试验条件 / Resistance to Soldering Heat Test Conditions

温度：260±5°C

时间：10±1 sec.

Temp.:260±5°C

Time:10±1 sec

包装规格 / Packaging SPEC.

卷盘包装 / REEL

Package Type 封装形式	Units 包装数量					Dimension 包装尺寸 (unit: mm ³)		
	Units/Reel 只/卷盘	Reels/Inner Box 卷盘/盒	Units/Inner Box 只/盒	Inner Boxes/Outer Box 盒/箱	Units/Outer Box 只/箱	Reel	Inner Box 盒	Outer Box 箱
TO-252	2,500	2	5,000	6	30,000	13" ×16	360×360×50	380×335×366

套管包装 / TUBE

Package Type 封装形式	Units 包装数量					Dimension 包装尺寸 (unit: mm ³)		
	Units/Tube 只/套管	Tubes/Inner Box 套管/盒	Units/Inner Box 只/盒	Inner Boxes/Outer Box 盒/箱	Units/Outer Box 只/箱	Tube 套管	Inner Box 盒	Outer Box 箱
TO-251/252	75	48	3,600	5	18,000	526×20.5×5.25	555×164×50	575×290×180

使用说明 / Notices