

# BRCS120P04ZCQ

Rev.A Jul.-2021

## 描述 / Descriptions

PDFN5×6 封装 P 沟道场效应管。

P-Channel MOSFET in a PDFN5×6 Plastic Package.

## 特征 / Features

低电阻可最大地降低导电损耗；低栅极电荷，可实现快速切换；低热阻；符合 AEC-Q101 标准高可靠性要求；无卤产品。

Low  $R_{DS(ON)}$  to minimize conductive loss; low Gate Charge for fast switching; Low Thermal resistance; Qualified to AEC-Q101 Standards for High Reliability; HF Product.

## 用途 / Applications

笔记本电脑交流输入负载开关，电池保护充电/放电，满足汽车应用的严格要求。

Notebook AC-in load switch, Battery Protection Charge/Discharge, Meet the stringent requirements of automotive applications.

## 内部等效电路 / Equivalent Circuit

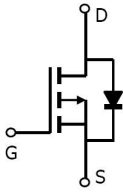

## 引脚排列 / Pinning

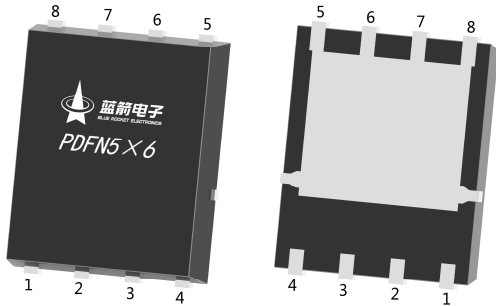

PIN1、2、3: S      PIN4: G      PIN5、6、7、8: D

Pin	极性
1	S
2	S
3	S
4	G
5	D
6	D
7	D
8	D

## 印章代码 / Marking

见印章说明。

See Marking Instructions.

**极限参数 / Absolute Maximum Ratings( $T_a=25^{\circ}\text{C}$ )**

参数 Parameter	符号 Symbol	数值 Rating	单位 Unit
Drain-Source Voltage	$V_{DS}$	-40	V
Drain Current - Continuous	$I_D(T_c=25^{\circ}\text{C})$	-45	A
Drain Current – Pulsed	$I_{DM}$	-120	A
Gate-Source Voltage	$V_{GS}$	$\pm 20$	V
Power Dissipation	$P_D(T_c=25^{\circ}\text{C})$	40	W
Single Pulse Avalanche Energy(L=0.5mH)	$E_{AS}$	317.5	mJ
Avalanche Current(L=0.5mH)	$I_{AS}$	-31.5	A
Junction and Storage Temperature Range	$T_j, T_{stg}$	-55 to 150	$^{\circ}\text{C}$
Thermal resistance, junction - ambient	$t \leq 10\text{s}$	$R_{\theta JA}$	$^{\circ}\text{C/W}$
	Steady-State		
Thermal resistance, junction - case	Steady-State	$R_{\theta JC}$	3.1

**电性能参数 / Electrical Characteristics( $T_a=25^{\circ}\text{C}$ )**

参数 Parameter	符号 Symbol	测试条件 Test Conditions	最小值 Min	典型值 Typ	最大值 Max	单位 Unit
Drain-Source Breakdown Voltage	$BV_{DSS}$	$I_D=-250\mu\text{A}$ $V_{GS}=0\text{V}$	-40	-48		V
Zero Gate Voltage Drain Current	$I_{DSS}$	$V_{DS}=-40\text{V}$ $V_{GS}=0\text{V}$			-1	$\mu\text{A}$
Gate-Body leakage current	$I_{GSS}$	$V_{DS}=0\text{V}$ , $V_{GS}=\pm 20\text{V}$			$\pm 100$	nA
Gate Threshold Voltage	$V_{GS(th)}$	$V_{DS}=V_{GS}$ $I_D=-250\mu\text{A}$	-1	-1.7	-2.5	V
Static Drain-Source On-Resistance	$R_{DS(ON)}$	$V_{GS}=-10\text{V}$ , $I_D=-20\text{A}$		11.4	13	m $\Omega$
		$V_{GS}=-4.5\text{V}$ , $I_D=-10\text{A}$		15	25	
Diode Forward Voltage	$V_{SD}$	$I_S=-1\text{A}$ , $V_{GS}=0\text{V}$			-1.2	V
Input Capacitance	$C_{iss}$	$V_{DS}=-25\text{V}$ $V_{GS}=0\text{V}$ $f=1.0\text{MHz}$		4760		pF
Output Capacitance	$C_{oss}$			2800		
Reverse Transfer Capacitance	$C_{rss}$			1960		
Gate resistance	$R_g$	$V_{GS}=0\text{V}$ $V_{DS}=0\text{V}$ $f=1\text{MHz}$		17.5		$\Omega$
Total Gate Charge	$Q_{g(10V)}$	$V_{GS}=-10\text{V}$ , $V_{DS}=-20\text{V}$ , $I_D=-20\text{A}$		34		nC
Total Gate Charge	$Q_{g(4.5V)}$			17.5		
Gate Source Charge	$Q_{gs}$			5.8		
Gate Drain Charge	$Q_{gd}$			9		

## 电性能参数 / Electrical Characteristics(Ta=25°C)

参数 Parameter	符号 Symbol	测试条件 Test Conditions	最小值 Min	典型值 Typ	最大值 Max	单位 Unit
Turn-On Delay Time	$t_{d(on)}$	$V_{GS}=-10V$ $V_{DS}=-20V$ $R_L=0.75\Omega$ $R_{GEN}=3\Omega$		11		ns
Turn-On Rise Time	$t_r$			7.8		
Turn-Off Delay Time	$t_{d(off)}$			44		
Turn-Off Fall Time	$t_f$			18		

## 电参数曲线图 / Electrical Characteristic Curve

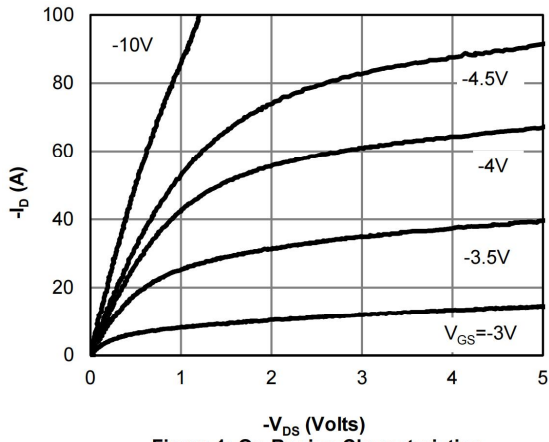

Figure 1: On-Region Characteristics

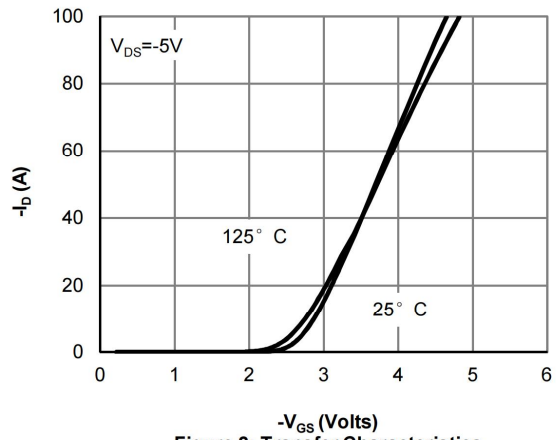

Figure 2: Transfer Characteristics

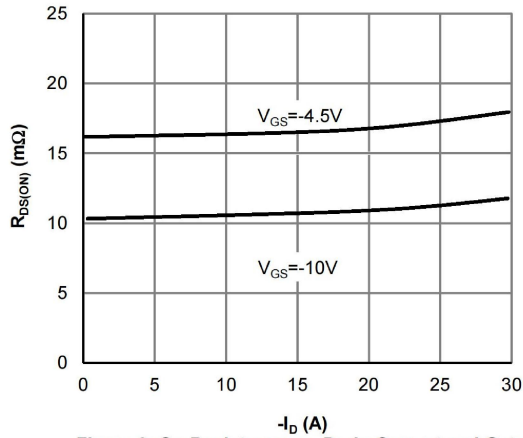

Figure 3: On-Resistance vs. Drain Current and Gate Voltage

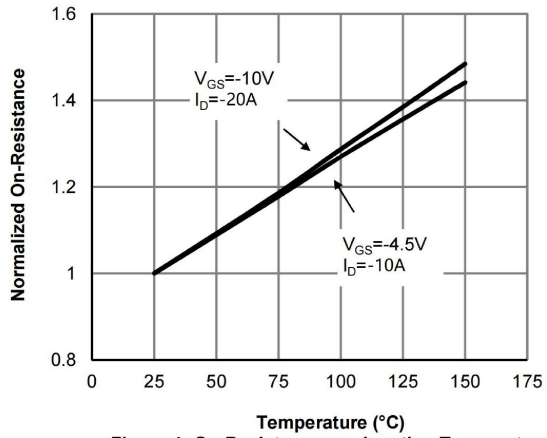

Figure 4: On-Resistance vs. Junction Temperature

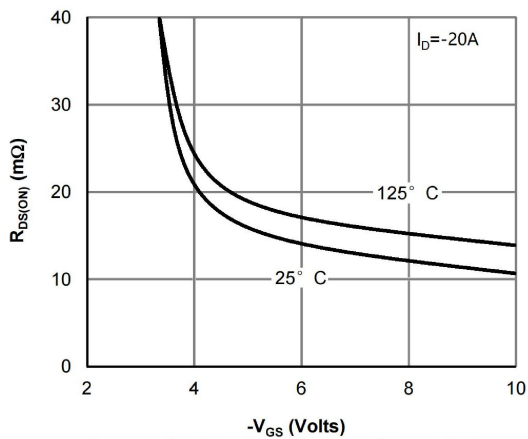

Figure 5: On-Resistance vs. Gate-Source Voltage

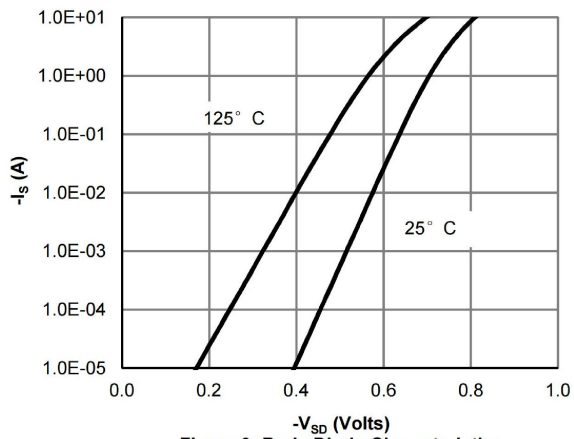
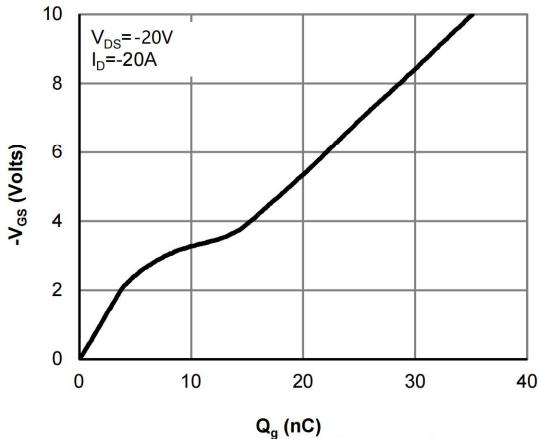
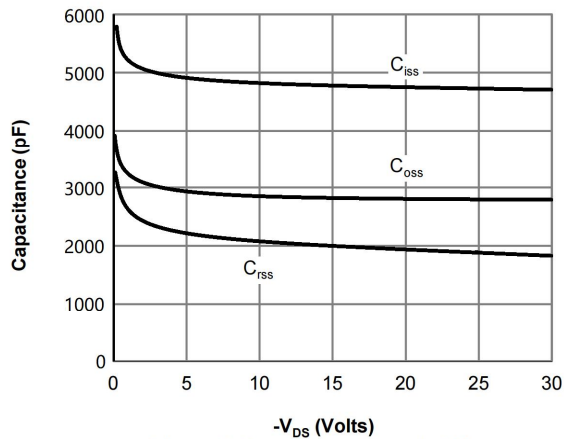

Figure 6: Body-Diode Characteristics

**电参数曲线图 / Electrical Characteristic Curve**



**Figure 7: Gate-Charge Characteristics**



**Figure 8: Capacitance Characteristics**

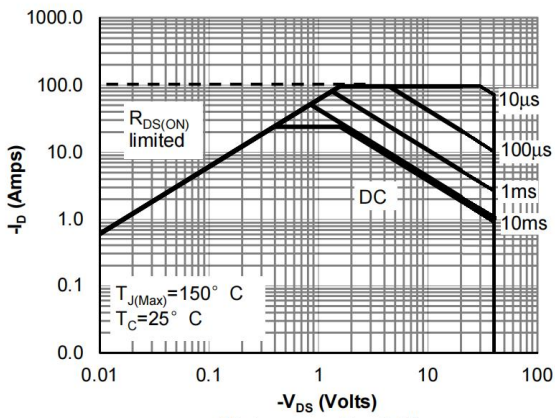

**Figure 9: Maximum Forward Biased Safe Operating Area**

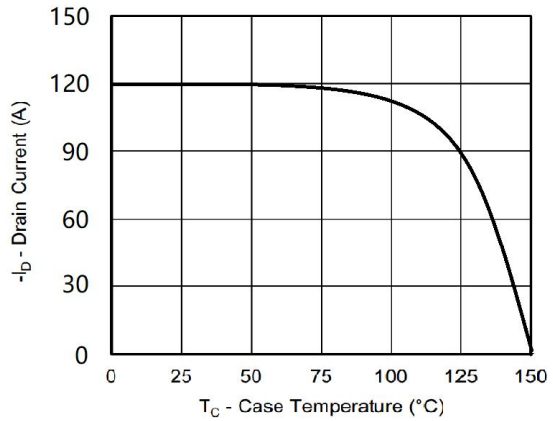

**Figure 10: Maximum Continuous Drain Current vs Case Temperature**

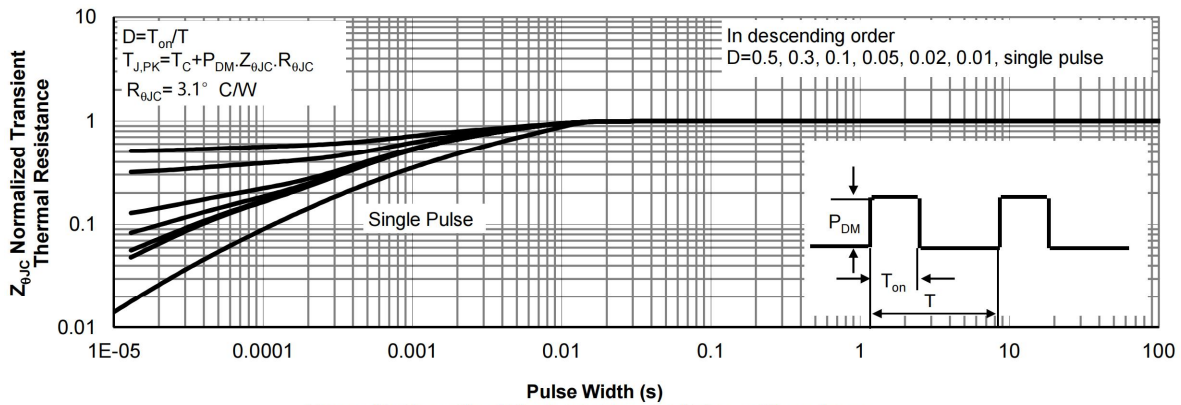

**Figure 11: Normalized Maximum Transient Thermal Impedance**

# BRCS120P04ZCQ

Rev.A Jul.-2021

## 外形尺寸图 / Package Dimensions

PDFN5 X6

Unit:mm

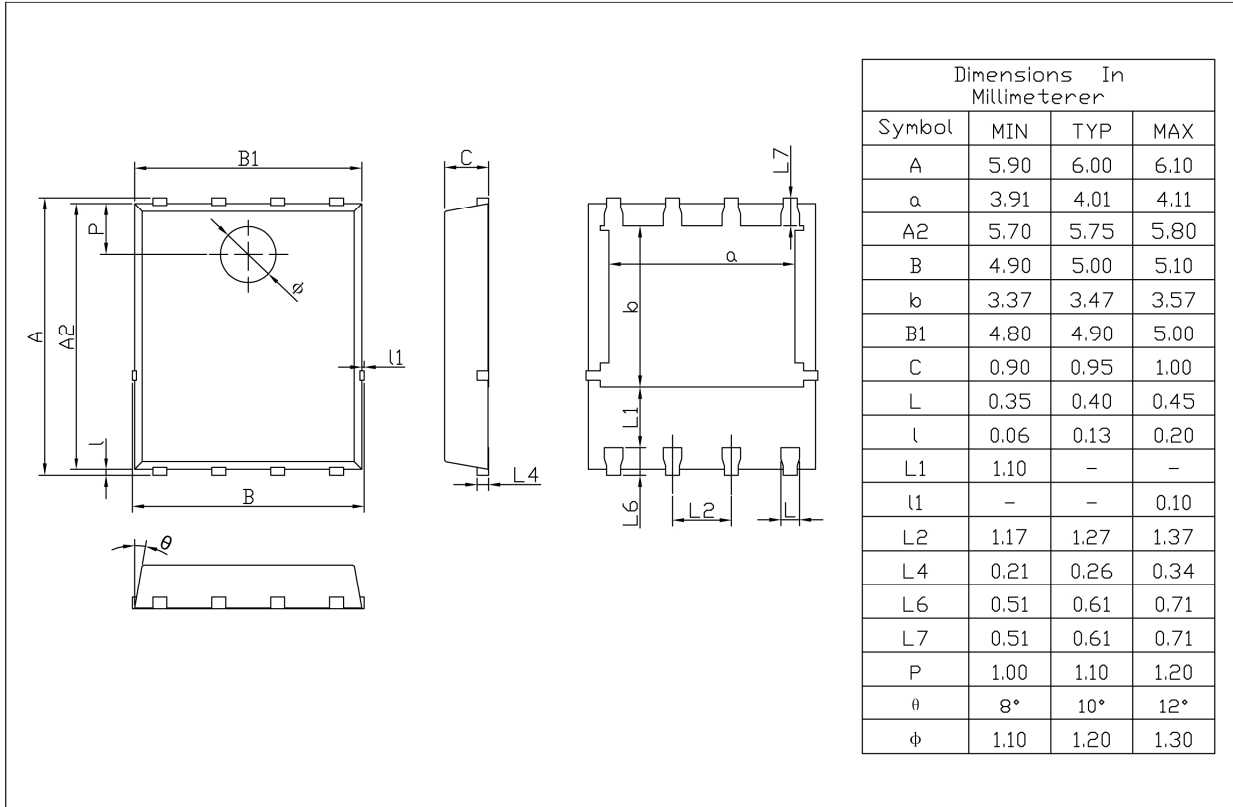

Rev.00 201812

**印章说明 / Marking Instructions**

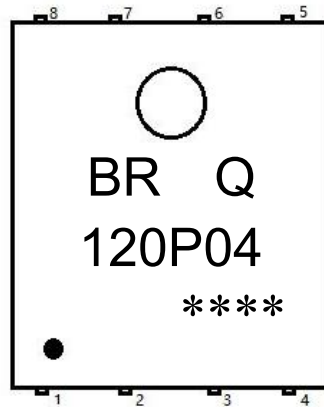

说明：

BR： 为公司代码

Q： 为汽车无卤产品标识

120P04： 为产品型号

\*\*\*\*： 为生产批号代码，随生产批号变化

Note：

BR： Company Code

Q: Automobile halogen-free product Code

120P04： Product Type

\*\*\*\*: Lot No. Code, code change with Lot No

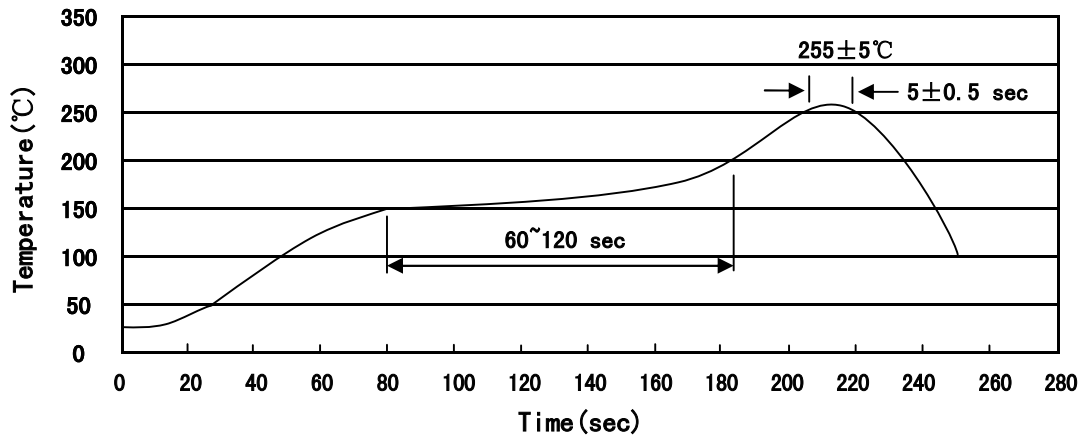
**回流焊温度曲线图(无铅) / Temperature Profile for IR Reflow Soldering(Pb-Free)**

说明：

- 1、预热温度 150~200°C，时间 60~120sec;
- 2、峰值温度 255±5°C，时间持续为 5±0.5sec;
- 3、焊接制程冷却速度为 2~10°C/sec.

Note:

- 1.Preheating:150~200°C, Time:60~120sec.
- 2.Peak Temp.:255±5°C, Duration:5±0.5sec.
3. Cooling Speed: 2~10°C/sec.

**耐焊接热试验条件 / Resistance to Soldering Heat Test Conditions**

温度：260±5°C

时间：10±1 sec.

Temp.:260±5°C

Time:10±1 sec

**包装规格 / Packaging SPEC.**

卷盘包装 / REEL

Package Type 封装形式	Units 包装数量					Dimension 包装尺寸 (unit: mm <sup>3</sup> )		
	Units/Reel 只/卷盘	Reels/Inner Box 卷盘/盒	Units/Inner Box 只/盒	Inner Boxes/Outer Box 盒/箱	Units/Outer Box 只/箱	Reel	Inner Box 盒	Outer Box 箱
PDFN5×6	5000	2	10000	6	60000	13"×12	360×360×50	380×335×366

**使用说明 / Notices**