

BRCS150P04DPQ

Rev.A Mar.-2023

描述 / Descriptions

TO-252 塑封封装 P 沟道场效应管。

P-CHANNEL MOSFET in a TO-252 Plastic Package.

特征 / Features

$R_{DS(on)}$ 小, 门电荷低, C_{rss} 小, 开关速度快, 沟槽工艺, 符合 AEC-Q101 标准高可靠性要求, 无卤产品。

Low $R_{DS(on)}$, low gate charge, low C_{rss} , fast switching, Trench Technologies, Qualified to AEC-Q101 Standards for High Reliability, HF Product.

用途 / Applications

用于低压电路如: 汽车电路、DC/DC 转换、便携式产品的电源高效转换, 满足汽车应用的严格要求。

Suited for low voltage applications such as automotive, DC/DC Converters, and high efficiency switching for power management in portable and battery operated products, Meet the stringent requirements of automotive applications.

内部等效电路 / Equivalent Circuit

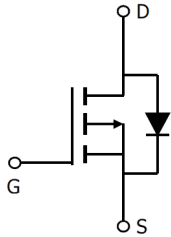

引脚排列 / Pinning

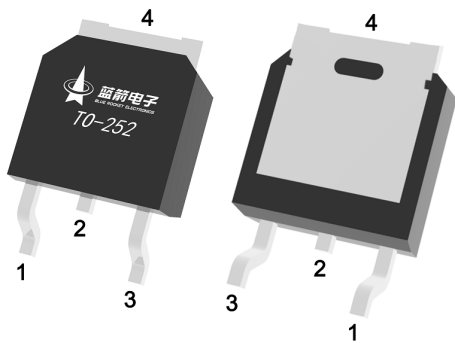

PIN 1 : G

PIN 2 : D

PIN 3 : S

PIN 4 : D

印章代码 / Marking

见印章说明。 See Marking Instructions.

极限参数 / Absolute Maximum Ratings(Ta=25°C)

参数 Parameter	符号 Symbol	数值 Rating	单位 Unit
Drain-Source Voltage	V_{DSS}	-40	V
Drain Current	$I_D(T_c=25^\circ C)$	-40	A
Drain Current - Pulsed	I_{DM}	-115	A
Gate-Source Voltage	V_{GS}	± 20	V
Avalanche Current	I_{AS}	24.5	A
Single Pulsed Avalanche Energy (L=0.5mH)	E_{AS}	210	mJ
Power Dissipation	$P_D(T_c=25^\circ C)$	52	W
Storage Temperature Range	T_{stg}	-55~150	$^\circ C$
Thermal Resistance-Junction to Ambient	$R_{\theta JA}$	$t \leq 10s$	20
		Steady-State	50
Thermal Resistance-Junction to Case	$R_{\theta JC}$	2.4	$^\circ C/W$

电性能参数 / Electrical Characteristics(Ta=25°C)

参数 Parameter	符号 Symbol	测试条件 Test Conditions	最小值 Min	典型值 Typ	最大值 Max	单位 Unit
Drain-Source Breakdown Voltage	BV_{DSS}	$V_{GS}=0V$ $I_D=-250\mu A$	-40			V
Zero Gate Voltage Drain Current	I_{DSS}	$V_{DS}=-40V$ $V_{GS}=0V$			1.0	μA
Gate-Body Leakage Current Forward	I_{GSS}	$V_{GS}=\pm 20V$ $V_{DS}=0V$			± 0.1	μA
Gate Threshold Voltage	$V_{GS(th)}$	$V_{DS}=V_{GS}$ $I_D=-250\mu A$	-1.0	-1.7	-2.5	V
Static Drain-Source On-Resistance	$R_{DS(on)}$	$V_{GS}=-10V$ $I_D=-20A$		13	15	m Ω
		$V_{GS}=-4.5V$ $I_D=-10A$		17	30	
Drain-Source Diode Forward Voltage	V_{SD}	$V_{GS}=0V$ $I_S=-1A$			-1.2	V
Gate resistance	R_g	$V_{GS}=0V$ $f=1MHz$ $V_{DS}=0V,$		6.5		Ω
Input Capacitance	C_{iss}	$V_{DS}=-25V$ $V_{GS}=0V$ $f=1.0MHz$		2680		pF
Output Capacitance	C_{oss}			1150		
Reverse Transfer Capacitance	C_{rss}			870		
Total Gate Charge	$Q_g(10V)$	$V_{GS}=-10V$ $V_{DS}=-20V$ $I_D=-20A$		42		nC
Total Gate Charge	$Q_g(4.5V)$			18.6		
Gate Source Charge	Q_{gs}			7		
Gate Drain Charge	Q_{gd}			8.6		

电性能参数 / Electrical Characteristics(Ta=25°C)

参数 Parameter	符号 Symbol	测试条件 Test Conditions	最小值 Min	典型值 Typ	最大值 Max	单位 Unit
Turn-On Delay Time	$t_{d(on)}$	$V_{GS}=-10V$ $V_{DS}=-20V$ $R_L=1\Omega$ $R_{GEN}=3\Omega$		9.4		ns
Turn-On Rise Time	t_r			20		
Turn-Off Delay Time	$t_{d(off)}$			55		
Turn-Off Fall Time	t_f			30		

电参数曲线图 / Electrical Characteristic Curve

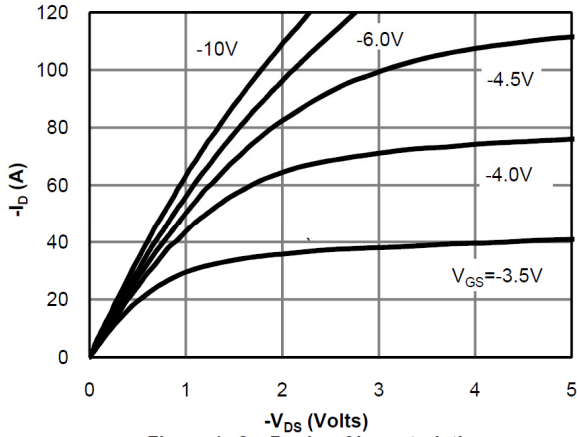

Figure 1: On-Region Characteristics

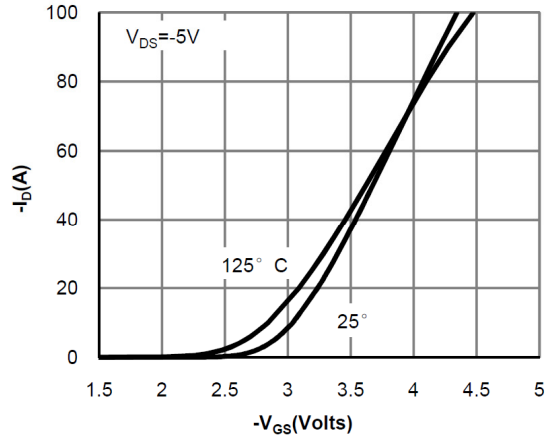

Figure 2: Transfer Characteristics

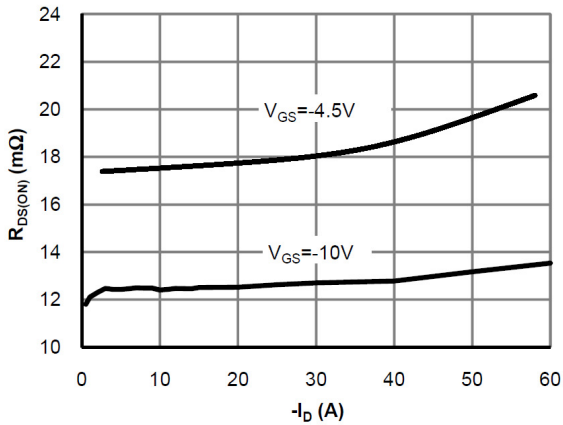

Figure 3: On-Resistance vs. Drain Current and Gate Voltage

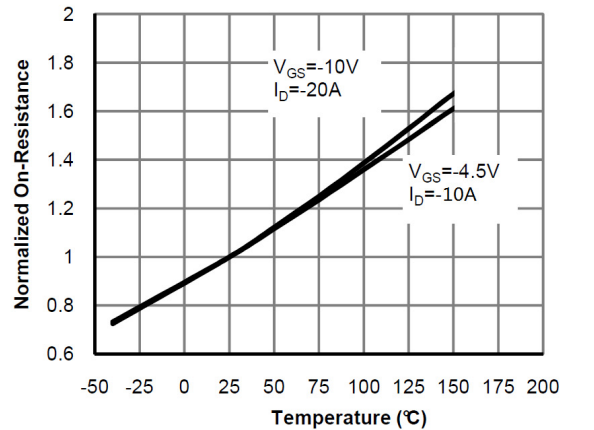

Figure 4: On-Resistance vs. Junction Temperature

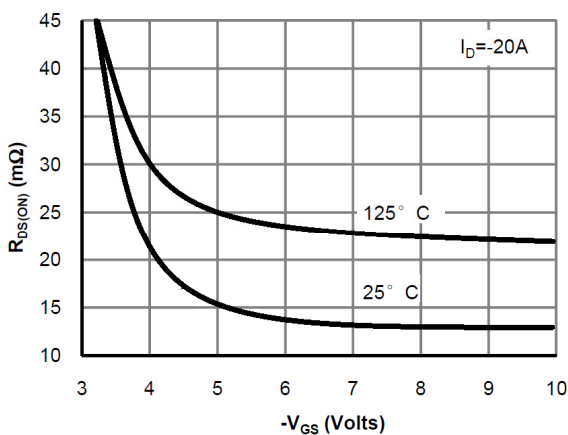

Figure 5: On-Resistance vs. Gate-Source Voltage

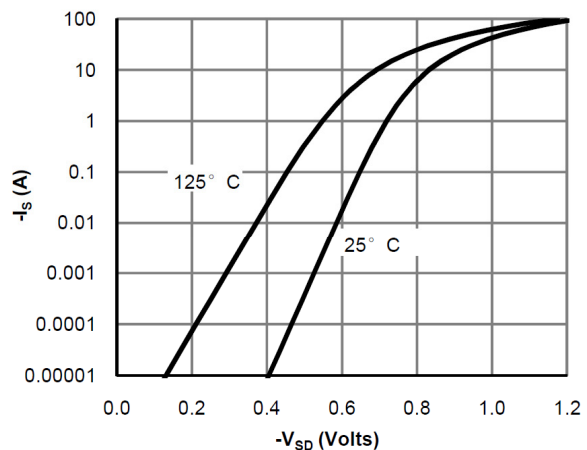

Figure 6: Body-Diode Characteristics

电参数曲线图 / Electrical Characteristic Curve

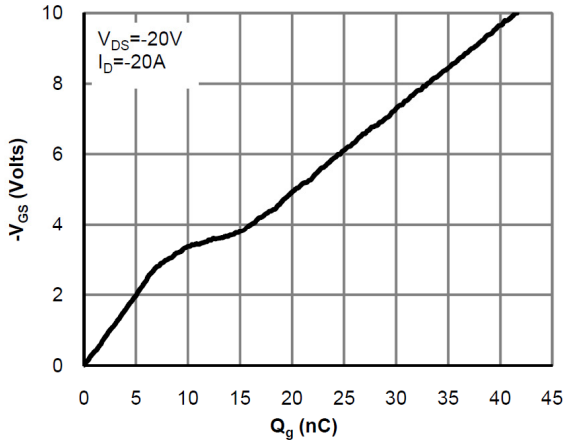

Figure 7: Gate-Charge Characteristics

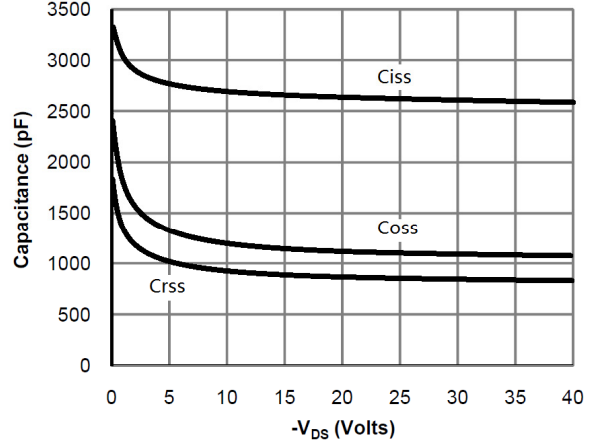

Figure 8: Capacitance Characteristics

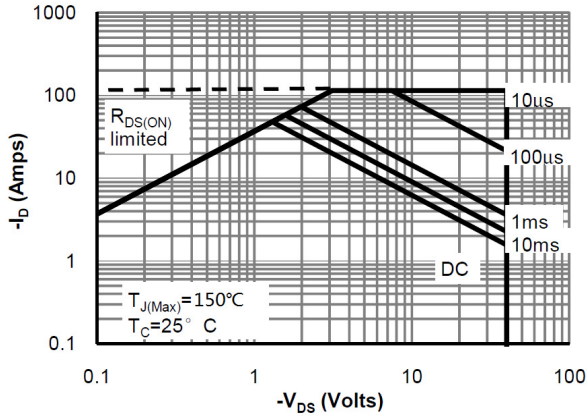

Figure 9: Maximum Forward Biased Safe Operating Area

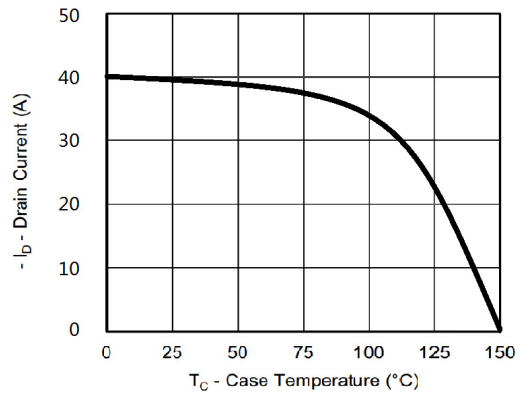

Figure 10: Maximum Continuous Drain Current vs Case Temperature

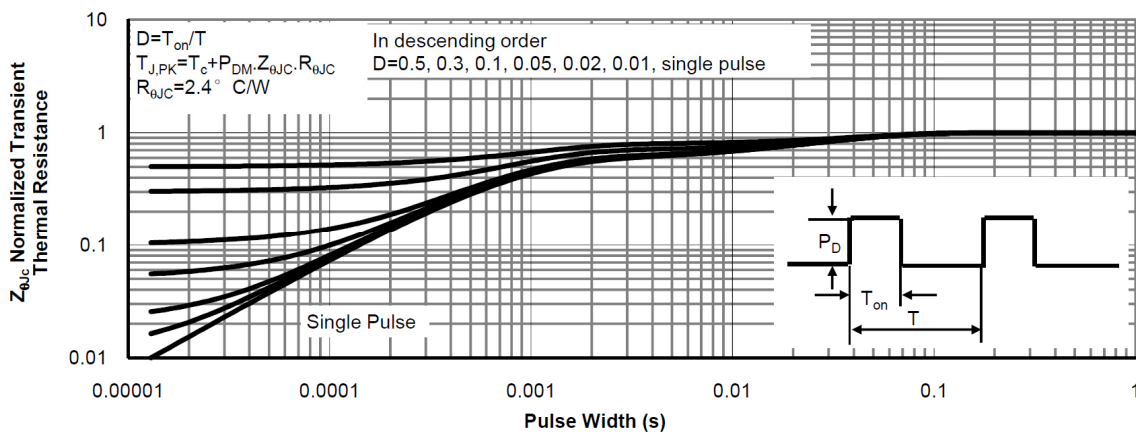
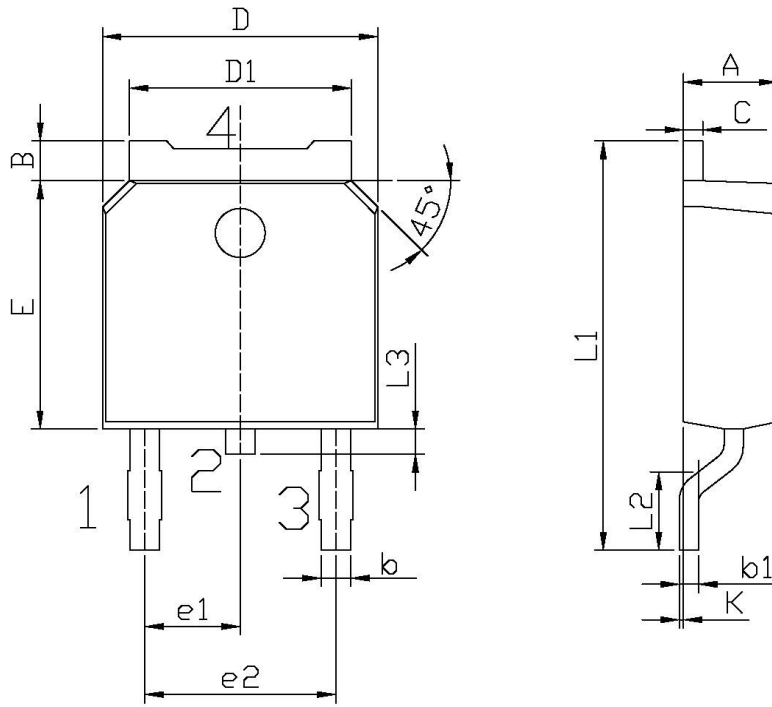

Figure 11: Normalized Maximum Transient Thermal Impedance

外形尺寸图 / Package Dimensions



单位: mm

Symbol	Dimensions In Millimeters		Symbol	Dimensions In Millimeters	
	Min	Max		Min	Max
A	2.20	2.40	E	5.95	6.25
B	0.95	1.25	e1	2.24	2.34
b	0.70	0.90	e2	4.43	4.73
b1	0.45	0.55	L1	9.85	10.35
C	0.45	0.55	L2	1.70	2.00
D	6.45	6.75	L3	0.60	0.90
D1	5.10	5.50	K	0.00	0.10

TO-252

印章说明 / Marking Instructions

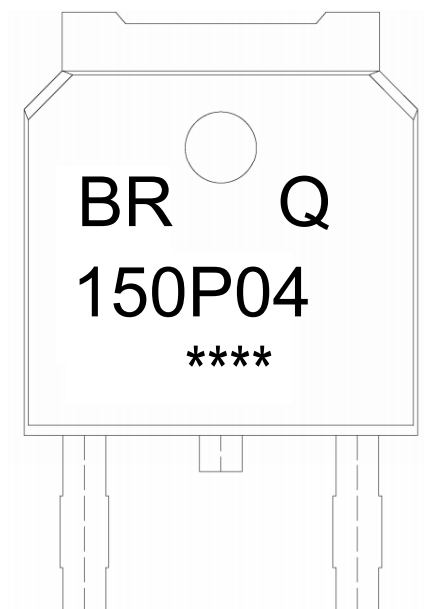

说明：

BR： 为公司代码

Q： 为汽车无卤产品标识

150P04： 为型号代码

****： 为生产批号代码，随生产批号变化

Note:

BR: Company Code

Q: Automobile halogen-free product Code

150P04: Product Type Code.

****: Lot No. Code, code change with Lot No

回流焊温度曲线图(无铅) / Temperature Profile for IR Reflow Soldering (Pb-Free)

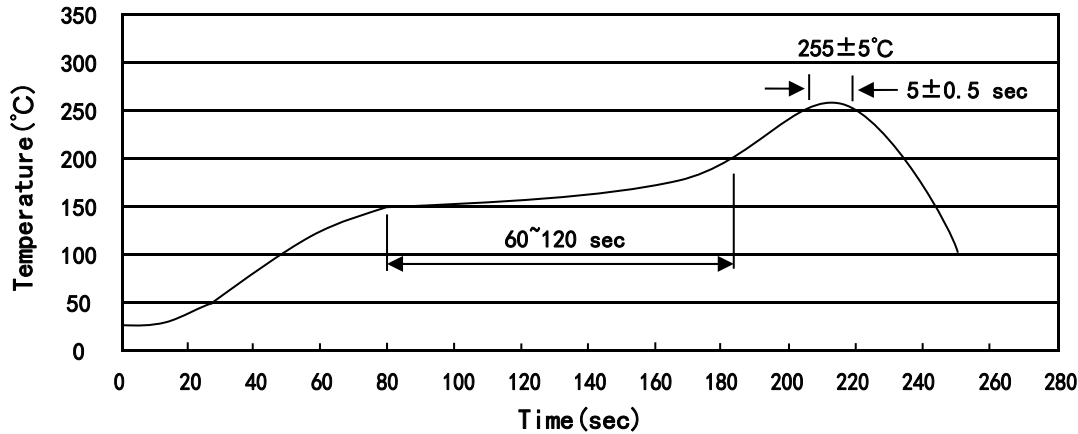

说明：

- 1、预热温度 150 ~ 200°C，时间 60 ~ 120sec;
- 2、峰值温度 255±5°C，时间持续为 5±0.5sec;
- 3、焊接制程冷却速度为 2 ~ 10°C/sec.

Note:

- 1.Preheating:150~200°C, Time:60~120sec.
- 2.Peak Temp.:255±5°C, Duration:5±0.5sec.
3. Cooling Speed: 2~10°C/sec.

耐焊接热试验条件 / Resistance to Soldering Heat Test Conditions

温度：260±5°C

时间：10±1 sec.

Temp.:260±5°C

Time:10±1 sec

包装规格 / Packaging SPEC.

卷盘包装 / REEL

Package Type 封装形式	Units 包装数量					Dimension 包装尺寸 (unit: mm ³)		
	Units/Reel 只/卷盘	Reels/Inner Box 卷盘/盒	Units/Inner Box 只/盒	Inner Boxes/Outer Box 盒/箱	Units/Outer Box 只/箱	Reel	Inner Box 盒	Outer Box 箱
TO-252	2,500	2	5,000	6	30,000	13" × 16	360×360×50	380×335×366

套管包装 / TUBE

Package Type 封装形式	Units 包装数量					Dimension 包装尺寸 (unit: mm ³)		
	Units/Tube 只/套管	Tubes/Inner Box 套管/盒	Units/Inner Box 只/盒	Inner Boxes/Outer Box 盒/箱	Units/Outer Box 只/箱	Tube 套管	Inner Box 盒	Outer Box 箱
TO-251/252	75	48	3,600	5	18,000	526×20.5×5.25	555×164×50	575×290×180

使用说明 / Notices